

- GENERAL NOTES**
- ON STRAIGHT RUNS OF FENCE, PULL POSTS SHALL BE USED AT 500' CENTERS FOR TYPE 1 AND 330' CENTERS FOR TYPE 2.
  - ALL FENCING MATERIALS SHALL BE IN ACCORDANCE WITH THE STANDARD SPECIFICATIONS.
  - WHERE R.O.W. FENCE FOLLOWS R.O.W. LINE IT SHALL BE INSTALLED PARALLEL TO AND 6" INSIDE THE R.O.W. LINE ON TOLLWAY PROPERTY.
  - LINE POSTS AND BRACES SHALL BE ON TOLLWAY SIDE OF FENCE FABRIC.
  - WHEN THE TENSION OF THE FENCE TENDS TO PULL THE POSTS FROM THE GROUND, THE LINE POSTS SHALL BE ANCHORED WITH ANCHORAGE SPECIFIED FOR CORNER POSTS.
  - AT LOCATION WHERE THE PROPOSED FENCE IS TO BE CONNECTED TO AN EXISTING POST, THE REQUIRED CONNECTIONS AND BRACING INCLUDING ALL NECESSARY HARDWARE SHALL BE CONSIDERED INCIDENTAL TO THE FENCE OF THE TYPE SPECIFIED.

- WHEN THE FENCE LINE HAS A CHANGE IN DIRECTION OF 10° OR MORE, A CORNER POST SHALL BE PLACED AT THE POINT OF CHANGE, WHERE THE ANGLE OF CHANGE IS LESS THAN 10° A PULL POST SHALL BE USED.
- WHERE GRADE LINE HAS A CHANGE IN SLOPE OF 10° OR MORE, A CORNER POST WITH BRACING AS REQUIRED SHALL BE PLACED, WHERE ANGLE IS LESS THAN 10° LINE POST MAY BE USED.
- WHERE TYPE 1 FENCE IS USED, THE FABRIC SHALL BE KNUCKLED SELVAGE ON TOP AND TWISTED AND BARBED SELVAGE ON BOTTOM.
- PLACEMENT OF BRACED END POSTS OR CORNER POSTS WITHIN THE CLEAR ZONE SHALL BE AVOIDED.

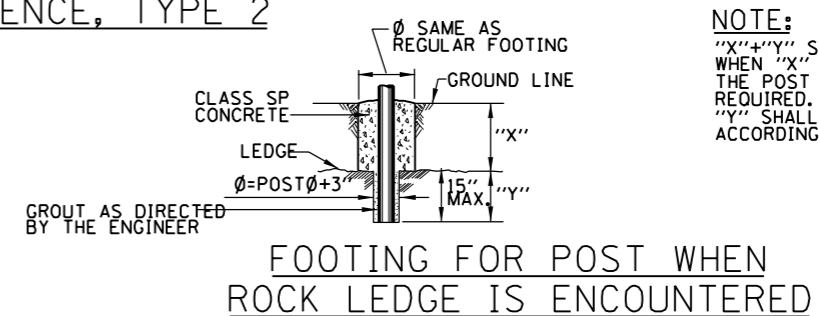

**NOTE:**  
 "X" + "Y" SHALL NOT EXCEED 30" WHEN "X" IS 0" TO 15" "Y"=15", AND THE POST SHALL BE SHORTENED AS REQUIRED. WHEN "X" EXCEEDS 15" "Y" SHALL BE DECREASED ACCORDINGLY.

APPROVED *Paul Kovacs* CHIEF ENGINEER DATE 7-1-2009

DATE	REVISIONS	
7-1-2009	R.O.W. FENCE TYPES 1 AND 2 FENCE DETAILS	RIGHT OF WAY FENCE
		STANDARD D1-01

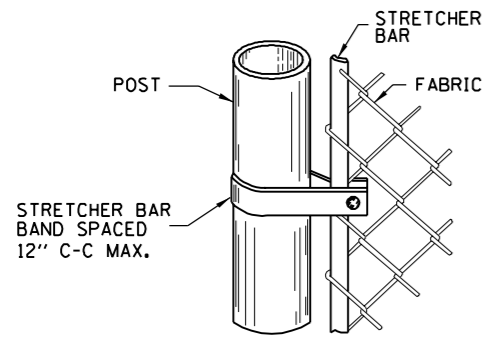

STRETCHER BARS SHALL BE GALVANIZED FLAT STEEL BAR NOT LESS THAN 1/4" x 3/4" AND THE STRETCHER BAR BANDS SHALL BE GALVANIZED FLAT STEEL BAR NOT LESS THAN 1/8" x 1" WITH A 3/8" GALVANIZED CARRIAGE BOLT.

**METHOD OF FASTENING  
STRETCHER BAR TO POST**

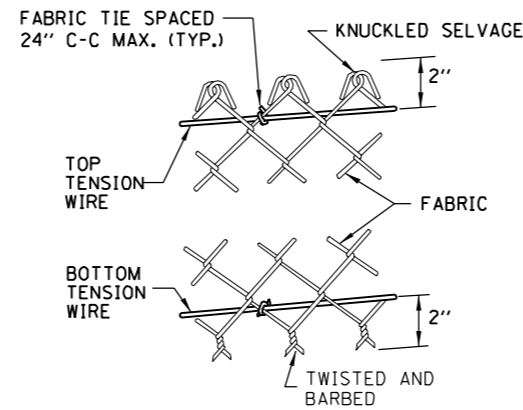

**METHOD OF TYING  
FABRIC TO TENSION WIRES**

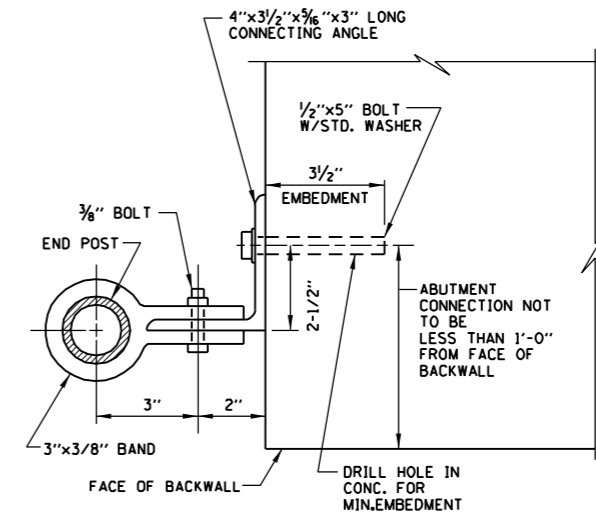

**ABUTMENT CONNECTION DETAIL**

**NOTES FOR ABUTMENT CONNECTION:**

1. WHEN ROLL FORMED SECTION IS USED IN LIEU OF PIPE AS END POST, THE POST SHALL BE BOLTED DIRECTLY TO THE ABUTMENT WALL WITH 2 1/2" x 5" BOLTS WITH STANDARD WASHERS MEETING THE APPROVAL OF THE ENGINEER.

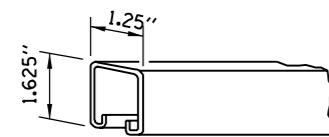

**BRACE SECTION  
1.25 LBS/LF**

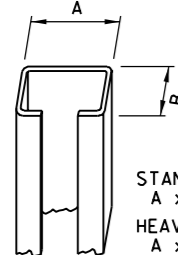

STANDARD "C" - 2.28 LBS/LF  
A x B = 1.875" x 1.625"  
HEAVY "C" - 2.70 LBS/LF  
A x B = 2.250" x 1.625"

**LINE POST "C" SECTION**

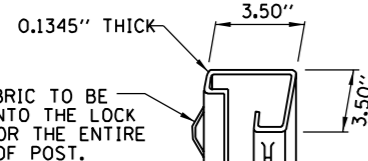

**TERMINAL POST SECTION  
5.10 LBS/LF**

**DETAILS OF ROLL FORMED SECTIONS**

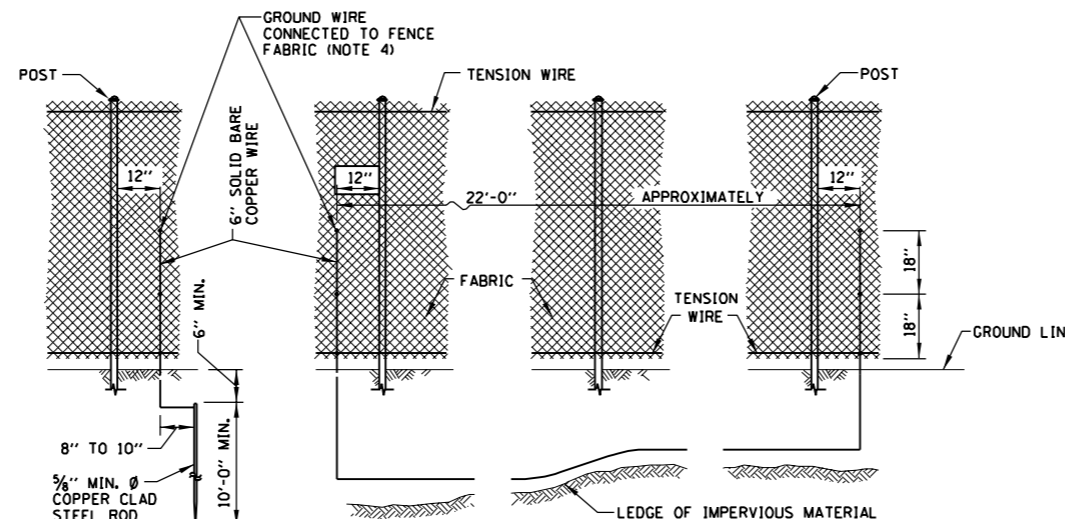

**STANDARD GROUND**

**COUNTERPOISE GROUND (ALTERNATE)**

**NOTES FOR STANDARD AND COUNTERPOISE GROUND:**

1. THE INTERVALS FOR GROUNDING CONTINUOUS FENCING SHALL NOT EXCEED 500 FEET IN URBAN AREAS AND 1000 FEET IN RURAL AREAS. FENCE ADJACENT TO A GATE SHALL BE GROUNDED A MAXIMUM DISTANCE 100 FEET EACH SIDE OF THE GATE.
2. FENCE CROSSING UNDER A POWER LINE SHALL BE GROUNDED, ONCE DIRECTLY UNDER THE CROSSING AND ONE ON EACH SIDE AT 25 TO 50 FEET AWAY. FENCE LOCATED DIRECTLY UNDER A TELEPHONE WIRE OR CABLE CROSSING SHALL HAVE A SINGLE GROUND.
3. COUNTERPOISE GROUNDS SHALL BE USED AT LOCATIONS WHERE GROUND RODS CAN NOT BE DRIVEN DUE TO IMPERVIOUS EARTH MATERIALS.
4. THE GROUND WIRES SHALL BE CONNECTED TO FENCE FABRIC AND GROUND ROD BY STAINLESS STEEL BOLTS AND WASHERS. THE LOWER CONNECTION OF THE GROUND WIRE SHALL BE MADE TO THE BOTTOM TENSION WIRE.
5. SEE SHEET 2 (OF 2) IN THIS SERIES FOR ADDITIONAL DETAILS AND GENERAL NOTES.

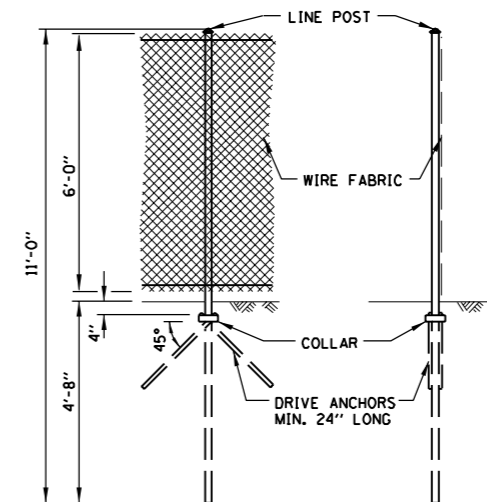

**ALTERNATE  
DRIVEN LINE POST ANCHORAGE  
WITH OR WITHOUT DRIVE ANCHORS**

**NOTE FOR FENCE POST:**

ALTERNATE DRIVEN LINE POST ANCHORAGE IS OPTIONAL. DRIVEN LINE POST ANCHORAGE WITHOUT DRIVE ANCHORS MAY BE USED IN AVERAGE TO GOOD SOIL CONDITIONS. WHEN SOIL IS WEAKER ( $Q_u < 1.25$  TONS/ SQ. FT.) AND STABILITY OF THE POST IS QUESTIONABLE, DRIVE ANCHORS SHALL BE USED. TYPES, SHAPES, DIMENSIONS AND COATING REQUIREMENTS OF DRIVE ANCHORS (ANCHOR BLADES AND COLLARS) FOR DIFFERENT TYPE OF POSTS SHALL BE AS RECOMMENDED BY THE MANUFACTURER.

APPROVED *Paul Kovacs*  
CHIEF ENGINEER

DATE 7-1-2009

**ELECTRICAL GROUNDING DETAILS**

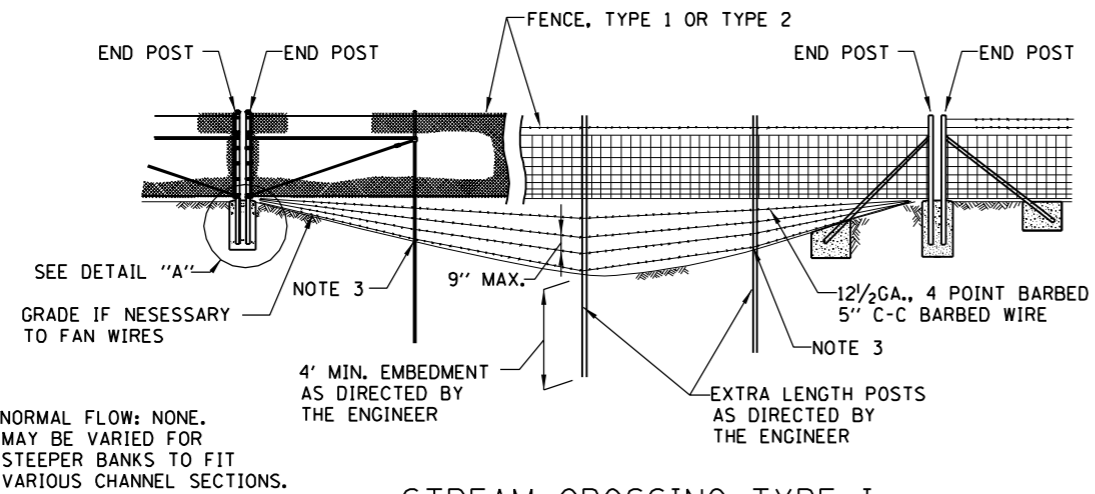

**STREAM CROSSING TYPE I**

NORMAL FLOW: NONE.  
MAY BE VARIED FOR  
STEEPER BANKS TO FIT  
VARIOUS CHANNEL SECTIONS.

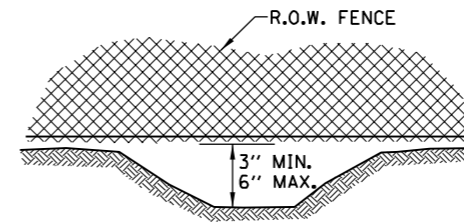

**FENCE INSTALLATION OVER DITCH**

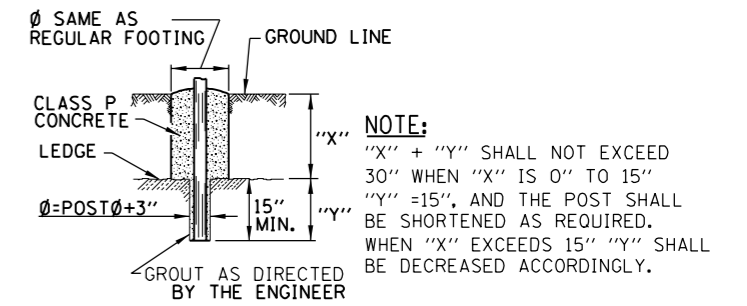

**FOOTING FOR POST WHEN ROCK LEDGE IS ENCOUNTERED**

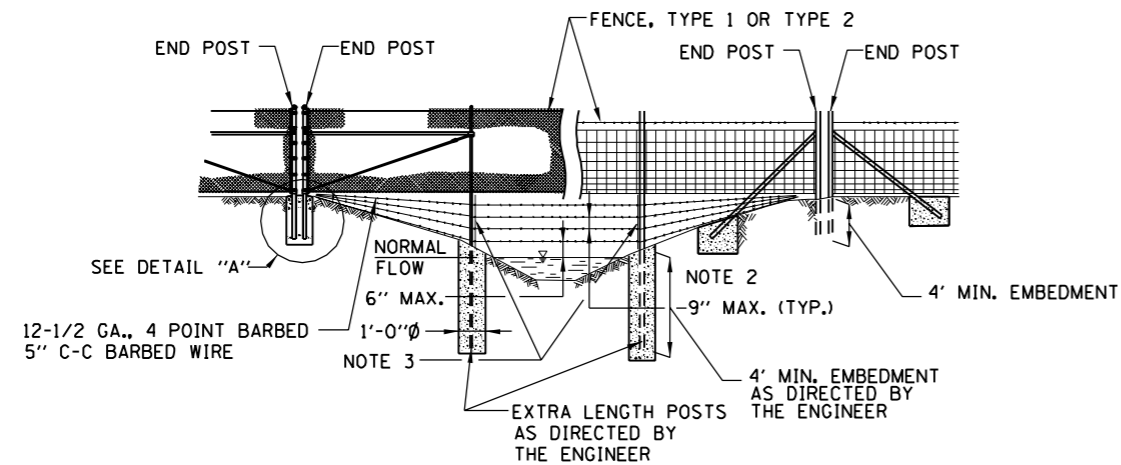

**STREAM CROSSING TYPE II**

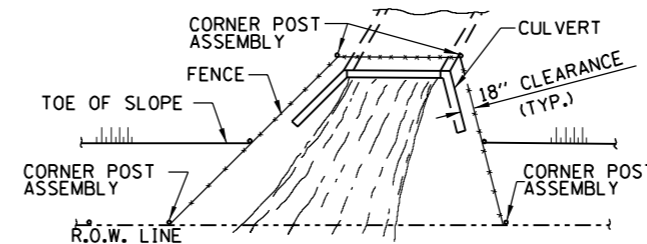

**PLAN AT HEADWALL**

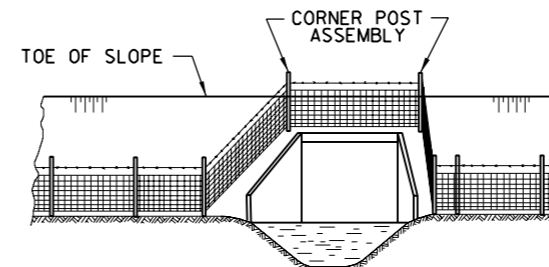

**ELEVATION**

**NOTES FOR INSTALLATION AROUND HEADWALL:**

1. THIS TYPE OF INSTALLATION IS TO BE USED ONLY WHEN SPECIFICALLY CALLED FOR IN THE CONTRACT PLANS.
2. WHEN THE WIDTH OF THE CULVERT MAKES NECESSARY TO ANCHOR A POST TO THE TOP OF THE CULVERT, A CAST IRON SHOE OR OTHER DEVICE APPROVED BY THE ENGINEER SHALL BE USED. THE COST OF ANCHORING THE POST SHALL BE INCIDENTAL TO THE TYPE OF FENCE REQUIRED.

**INSTALLATION AROUND HEADWALL**

**NOTES FOR STREAM CROSSING TYPE I AND TYPE II:**

1. THESE INSTALLATION CONDITIONS ARE TYPICAL AND ARE NOT TO BE CONSTRUED AS REPRESENTATIVE OF ALL CONDITIONS WHICH WILL BE ENCOUNTERED. CONSTRUCTION WILL BE VARIED AS REQUIRED OR DIRECTED TO MEET FIELD CONDITIONS.
2. FOR STREAM CROSSING OF THE TYPE REQUIRED THE BOTTOM BARBED WIRE SHALL BE ANCHORED TO CONCRETE FOOTING OR TO HOLES DRILLED IN POSTS, AND INTERMEDIATE WIRES SHALL BE TIED TO THE BOTTOM WIRE AND TO POSTS IN AN EVENLY SPACED FASHION TO PREVENT SLIPPAGE.
3. CONCRETE AND FITTINGS FOR ALL TYPES OF FENCE SHALL BE AS DETAILED FOR SIMILAR CONDITIONS ON STANDARD DRAWING SD XX-8A AND SD XX-8C.

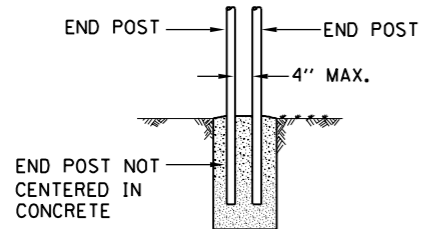

**DETAIL A**

THE FENCE FABRIC SHALL BE REPLACED BY BARBED WIRE STRANDS AT 12" MAXIMUM CENTERS BETWEEN THE END POSTS WHEN SHOWN ON THE PLANS THE BARBED WIRE STRANDS, IF REQUIRED, SHALL BE INCIDENTAL TO THE VARIOUS TYPES OF STREAM CROSSING REQUIRED.

SURVEY AND ROADWAY ITEMS

EXISTING	PROPOSED	
		CONSTRUCTION JOINT W/DOWEL BARS
		BENCHMARK
		CANTILEVER SIGN STRUCTURE
		DOUBLE COLUMN GROUND MOUNTED SIGN
		SINGLE COLUMN GROUND MOUNTED SIGN
		SPAN TYPE SIGN STRUCTURE
		TRIPLE COLUMN GROUND MOUNTED SIGN
		RUMBLE STRIP

EROSION & SEDIMENT CONTROL, LANDSCAPING ITEMS

EXISTING	PROPOSED		EXISTING	PROPOSED	
		CLEARING & GRADING LIMITS (LIMITS OF CONSTRUCTION)			EROSION CONTROL BLANKET
		DRAINAGE PATH			OVER SEEDING CLASS B1
		SUPER SILT FENCE			OVER SEEDING CLASS B2
		AGGREGATE BERM			SEEDING CLASS A1
		CULVERT INLET PROTECTION-STONE			SEEDING CLASS A2
		CULVERT INLET PROTECTION-FENCES			SEEDING CLASS A3
		DEWATERING BASIN			SEEDING CLASS A4
		FILTER FABRIC INLET PROTECTION			SEEDING CLASS A5
		INITIAL CONSTRUCTION ITEM			SEEDING CLASS A6
		RECTANGULAR INLET PROTECTION			SEEDING CLASS D1
		ROCK CHECK DAM			SODDING (SALT TOLERANT)
		ROLLED EXCELSIOR DITCH CHECK			TEMPORARY GROUND COVER
		SEDIMENT BASIN			TURF REINFORCEMENT MAT
		STABILIZED CONSTRUCTION ENTRANCE			
		STONE OUTLET STRUCTURE SEDIMENT TRAP			
		STREAM DIVERSION			
		TEMPORARY PIPE SLOPE DRAIN			
		TEMPORARY RIPRAP			
		TEMPORARY SWALE			
		TREES AND STUMP			
		URETHANE FOAM DITCH CHECK			
		DIVERSION DIKE			
		TEMPORARY STREAM CROSSING			

DRAINAGE AND UTILITY ITEMS; ROADWAY LIGHTING AND SIGNS









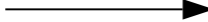

EXISTING	PROPOSED	
		BOX CULVERT WITH HEADWALL
		CABLE IN DUCT W/O GROUND
		LOW POINT
		OVERHEAD ELECTRICAL
		OVERHEAD TELEPHONE
		PIPE CULVERT
		LAKE OR POND
		QUARRY
		STREAM
		SWAMP
		CABLE OR CONDUIT TAG
		ELECTRICAL MANHOLE
		LIGHT-DUTY BOX
		ROADWAY LUMINAIRE
		STEEL TOWER
		TELEPHONE MANHOLE
		UNDERPASS LUMINAIRE
		WATER POINT
		WATERMAIN VALVE VAULT
		WATER WELL
		WOOD POLE



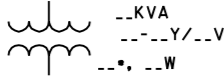

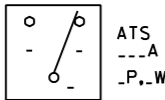
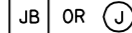

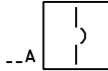

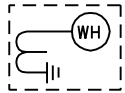





APPROVED: *Paul Kovacs* CHIEF ENGINEER DATE 7-1-2009

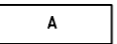

DATE	REVISIONS	
7-1-2009	REVISED SYMBOL & PATTERNS	SYMBOLS AND PATTERNS
		STANDARD D2-01

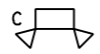
# ELECTRICAL AND MECHANICAL ITEMS

	HOME RUN TO PANEL AS NOTED
	INDICATES CIRCUIT TURNING DOWN
	INDICATES CIRCUIT TURNING UP
	GROUND ROD
	GROUNDING TRIAD
	TRANSFORMER
	MOTOR
	AUTOMATIC TRANSFER SWITCH (ATS)
	JUNCTION BOX
	DISCONNECT SWITCH
	CIRCUIT BREAKER
	MANUAL TRANSFER SWITCH
	SELF CONTAINED UTILITY METERING

	STANDBY GENERATOR
	PANEL CIRCUIT BREAKER
	MECHANICALLY HELD LIGHTING COIL
	CONTROL RELAY COIL
	SINGLE-POLE SWITCH
	DUPLEX RECEPTACLE
	4P, 4W, WEATHERPROOF RECEPTACLE WITH SPRING DOOR, BACK BOX, & ANGLE ADAPTER
	4P, 4W, WEATHERPROOF RECEPTACLE WITH SPRING DOOR & BACK BOX
	DUPLEX RECEPTACLE WITH GROUND FAULT PROTECTION
	CONTROL BUILDING LIGHTING 1' X 4' INDUSTRIAL FLUORESCENT FIXTURE, PORCELAIN REFLECTOR, ELECTRONIC BALLAST.
	COMPACT WALL-MOUNTED LOW WATTAGE HPS FIXTURE WITH WIRE GUARD & SINGLE FACTORY INSTALLED FUSE
	EMERGENCY LIGHT UNIT WITH 2-6 VOLT, 12 WATT SEALED BEAM HALOGEN LAMPS WITH WALL MOUNTING BRACKET
	LANE LIGHTING - HEAVY DUTY ALUMINUM HOUSING WITH ENCLOSED REFLECTOR & TEMPERED GLASS LENS W/AUTO REGULATOR BALLAST. ASYMMETRIC PATTERN
	WIRE
	CONDUIT

## EXISTING

## PROPOSED











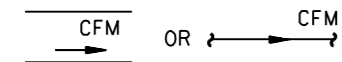
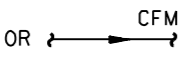
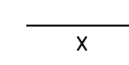
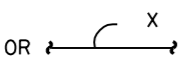
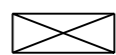
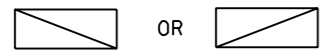
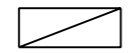
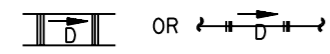
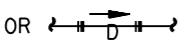
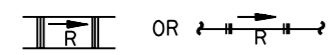
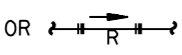
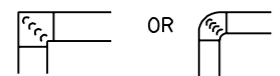
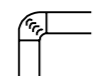
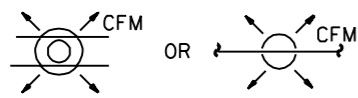
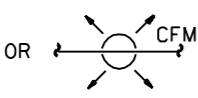
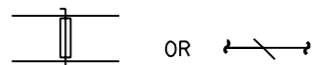
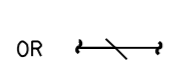
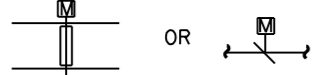
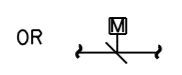
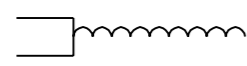
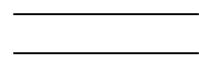
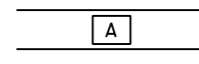
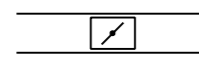
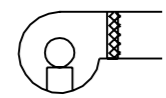
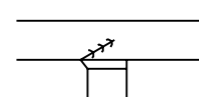
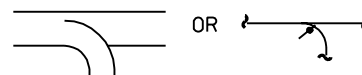







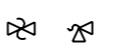

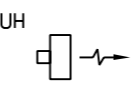
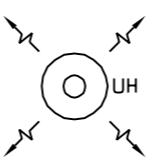
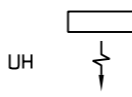



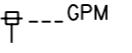



















_____ A _____	_____ A _____	COMPRESSED AIR (A)
_____ AR _____	_____ AR _____	ACID RESISTANT WASTE OR DRAIN
_____ ARV _____	_____ ARV _____	ACID RESISTANT VENT
_____ DS _____	_____ DS _____	STORM SEWER (DOWNSPOUT)
_____ G _____	_____ G _____	GAS LINE
_____ HG _____	_____ HG _____	HOT GAS BYPASS LINE (HG)
_____ HHWR _____	_____ HHWR _____	HEATING HOT WATER RETURN (HHWR)
_____ HHWS _____	_____ HHWS _____	HEATING HOT WATER SUPPLY (HHWS)
_____ IA _____	_____ IA _____	DRY COMPRESSED AIR (IA-INSTRUMENT AIR)
_____ P _____	_____ P _____	PROCESS WATER ("P" WATER) LINE
_____ PW _____	_____ PW _____	PROTECTED WATER OR PLANT WATER (PW)
_____ RD _____	_____ RD _____	REFRIGERANT DISCHARGE LINE (RD)
_____ RS _____	_____ RS _____	REFRIGERANT SUCTION LINE (RS)
_____ V _____	_____ V _____	VENT LINE (V)

**NOTE:**

ALL SYMBOLS AND PATTERNS ON THIS DRAWING ARE PROPOSED UNLESS OTHERWISE NOTED.



# ELECTRICAL AND MECHANICAL ITEMS

	<p>OR</p> 	<p>QUANTITY AND DIRECTION OF THE AIR FLOW</p>		
	<p>OR</p> 	<p>DUCT SIZE (FIRST FIGURE SIZE OF SHOWN, SECOND FIGURE SIZE OF SIDE NOT SHOWN.)</p>		
		<p>SUPPLY DUCT SECTION</p>		
	<p>OR</p> 	<p>RETURN OR EXHAUST DUCT SECTION</p>		
	<p>OR</p> 	<p>DUCT DROPS IN THE DIRECTION OF FLOW</p>		
	<p>OR</p> 	<p>DUCT RISES IN THE DIRECTION OF FLOW</p>		
	<p>OR</p> 	<p>TURNING VANES</p>		
	<p>OR</p> 	<p>8" THROAT DIAMETER CEILING DIFFUSER; AIR FLOW -- 100 CFM</p>		
	<p>OR</p> 	<p>BALANCING OR VOLUME DAMPER</p>		
	<p>OR</p> 	<p>MOTOR OPERATED DAMPER</p>		
		<p>FLEXIBLE DUCT</p>		
		<p>FIRE DAMPER</p>		
		<p>SOUND ATTENUATOR</p>		
		<p>ZONE DAMPER</p>		
		<p>FLEXIBLE CONNECTION AT FAN OR EQUIPMENT</p>		
		<p>EXTRACTOR</p>		
	<p>OR</p> 	<p>SPLITTER DAMPER</p>		
		<p>PLUG VALVE WITH MEMORY STOP (BALANCING)</p>		
		<p>PLUG VALVE</p>		
		<p>SOLENOID VALVE</p>		
		<p>TEMPERATURE CONTROL VALVE</p>		
		<p>THREE-WAY TEMPERATURE CONTROL VALVE DIAPHRAGM</p>		
		<p>THREE-WAY TEMPERATURE CONTROL VALVE TOP VIEW</p>		
		<p>PRESSURE REDUCING VALVE (NOS = INITIAL AND FINAL PRESSURE - PSIG)</p>		
		<p>AIR PRESSURE REDUCING STATION (NO. CORRESPONDS WITH AIR PRESSURE REDUCER SCHEDULE)</p>		
		<p>SAFETY VALVE (NOS. = PRESSURE SETTING - PSIG)</p>		
		<p>FLOAT OPERATED VALVE</p>		
		<p>QUICK COUPLING (QC)</p>		
		<p>HORIZONTAL UNIT HEATER (NO. CORRESPONDS WITH UNIT HEATER SCHEDULE)</p>		
		<p>VERTICAL UNIT HEATER (NO. CORRESPONDS WITH UNIT HEATER SCHEDULE)</p>		
		<p>CABINET TYPE UNIT HEATER (NO. CORRESPONDS WITH UNIT HEATER SCHEDULE)</p>		
		<p>THERMOSTAT OR ROOM TEMPERATURE SENSOR</p>		
		<p>GATE VALVE</p>		
		<p>FLOW SWITCH</p>		
		<p>VENTURI FLOW METER AND FLOW TO BE INDICATED</p>		
		<p>CONNECTION BETWEEN NEW AND EXISTING</p>		
				<p>GLOBE VALVE</p>
				<p>BUTTERFLY VALVE</p>
				<p>CHECK VALVE</p>
				<p>ANGLE GATE VALVE</p>
				<p>CONCENTRIC REDUCER</p>
				<p>ECCENTRIC REDUCER</p>
				<p>ORIFICE FLANGE</p>
				<p>CROSSOVER</p>
				<p>PIPE GUIDE</p>
				<p>EXPANSION JOINT (SLIP TYPE)</p>
				<p>EXPANSION JOINT (BELLOWS TYPE)</p>
				<p>AIR ELIMINATOR (AIR VENT)</p>
				<p>PIPE CAP</p>
				<p>STRAIGHT CROSS</p>
				<p>90° ELBOW</p>
				<p>90° ELBOW TURNED DOWN</p>
				<p>90° ELBOW TURNED UP</p>
				<p>SIDE OUTLET ELBOW TURNED DOWN</p>
				<p>SIDE OUTLET ELBOW TURNED UP</p>
				<p>LATERAL</p>
				<p>TEE</p>
				<p>TEE OUTLET UP</p>
				<p>TEE OUTLET DOWN</p>
				<p>UNION</p>
				<p>STRAINER</p>
				<p>PIPE ANCHOR</p>
				<p>THERMOMETER (NOS. = RANGE IN DEGREES FAHRENHEIT)</p>
				<p>PRESSURE, VACUUM OR COMPOUND GAUGE</p>

**NOTE:**

ALL SYMBOLS AND PATTERNS ON THIS DRAWING ARE PROPOSED UNLESS OTHERWISE NOTED.

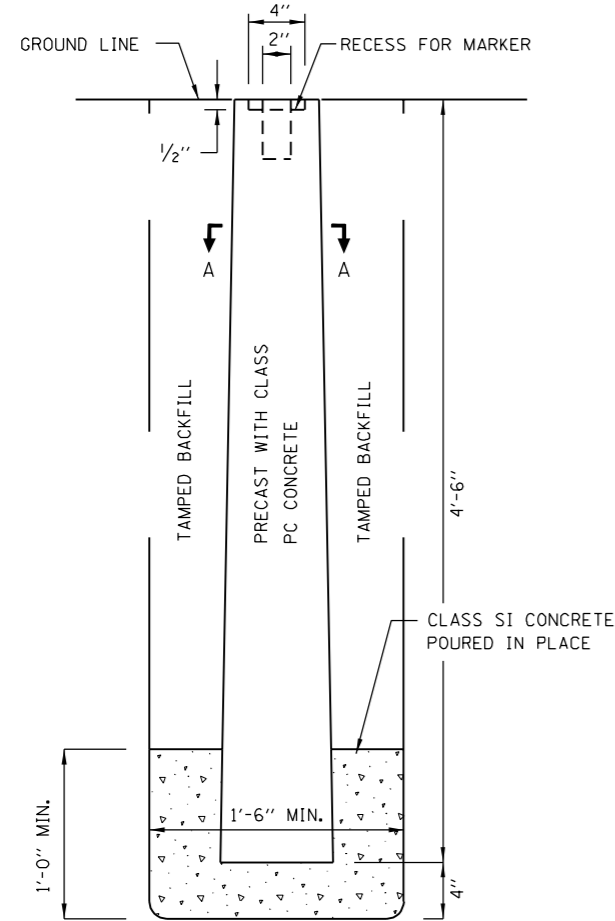
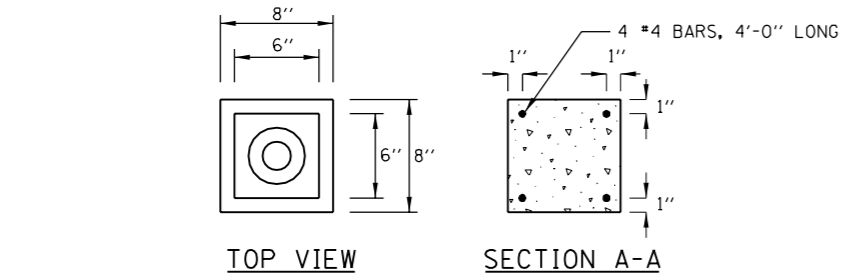

**MONUMENT DETAIL**

**NOTES FOR PERMANENT MONUMENT AND MARKER:**

1. RAISED MACHINE FINISHED SURFACE WILL BE PUNCHED AFTER SETTING TO SHOW CENTERLINE POINT.
2. MACHINED AREA AROUND RAISED SURFACE TO BE STAMPED WITH CORRECT CENTERLINE STATION AS DIRECTED BY THE ENGINEER.
3. MARKER TO BE SET IN MONUMENT WITH PURE CEMENT AND WATER OR MELTED SULPHUR.
4. MONUMENTS SHALL BE PLACED AT P.C.'S AND P.T.'S OF HORIZONTAL CURVES AND SPACED ALONG TANGENTS AND CURVES IN A WAY THAT A MINIMUM OF TWO MARKERS ARE ALWAYS INTER-VISIBLE.

**PERMANENT MONUMENT AND MARKER**

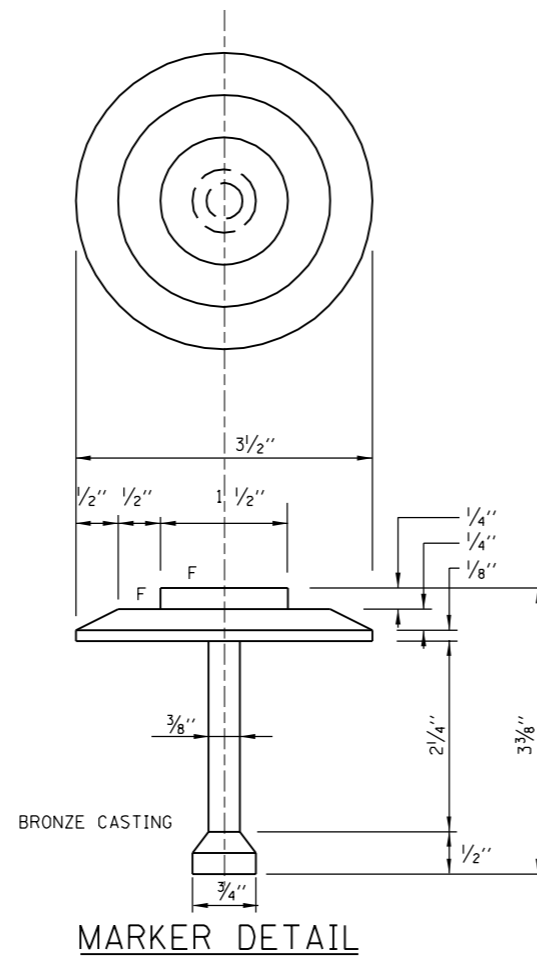

**MARKER DETAIL**

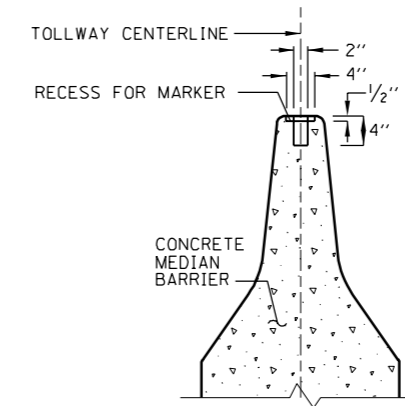

**TYPICAL CENTERLINE MARKER AT MEDIAN BARRIER**

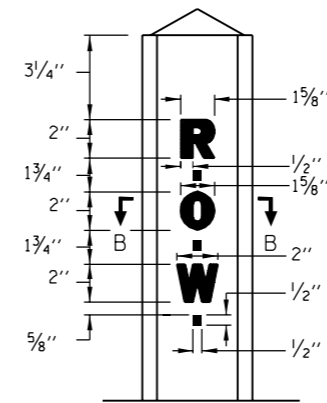

**LETTERING DETAIL**

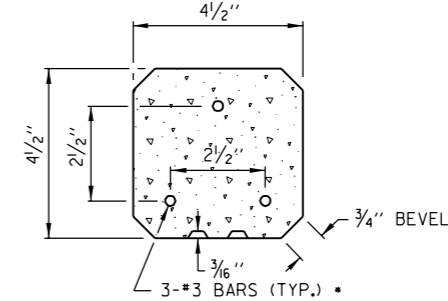

- METHOD A- 4'-2" LONG BARS
- METHOD B- 2'-6" LONG BARS

**SECTION B-B**

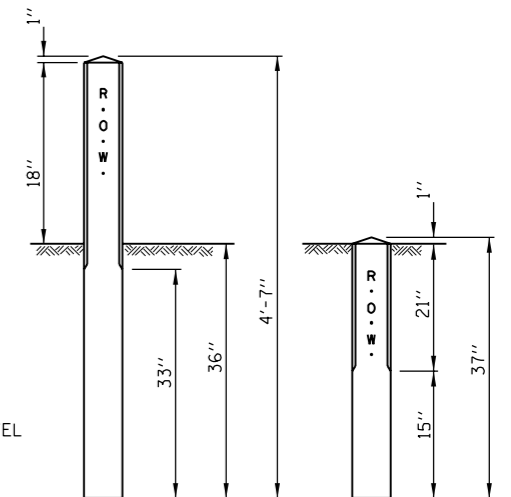

**METHOD A**

**METHOD B**

**RIGHT OF WAY MARKER**

**NOTES FOR RIGHT OF WAY MARKER:**

1. RIGHT OF WAY MARKERS SHALL BE PLACED ON STATE, COUNTY, AND TOWNSHIP ROADS AT THE FOLLOWING LOCATIONS:
  - (A) AT INTERVALS OF 1,000 FT. ON TANGENTS AND 500 FEET ON CURVES.
  - (B) AT ALL INTERSECTING ROADS EXCEPT STREETS IN SUBDIVISIONS OUTSIDE OF CORPORATE LIMITS
  - (C) AT EACH CORNER OF ALL OFFSETS
  - (D) OPPOSITE POINTS OF CURVATURE AND TANGENCY AND OPPOSITE THE MIDPOINT OF CURVES
2. MARKERS SHALL BE SET WITH BACK OF MARKER FLUSH WITH THE R.O.W. LINE.
3. CLASS SI CONCRETE SHALL BE USED IN THE POSTS.
4. METHOD B RIGHT OF WAY MARKERS SHALL BE USED WITHIN IMPROVED RESIDENTIAL AREAS AT THE LOCATIONS INDICATED ON THE PLANS OR AS DIRECTED BY THE ENGINEER.

APPROVED *Jeff Daley* CHIEF ENGINEER DATE 1-1-2007

DATE	REVISIONS

**Illinois Tollway**  
Open Roads for a Faster Future

MONUMENTS AND MARKERS

STANDARD D3-00

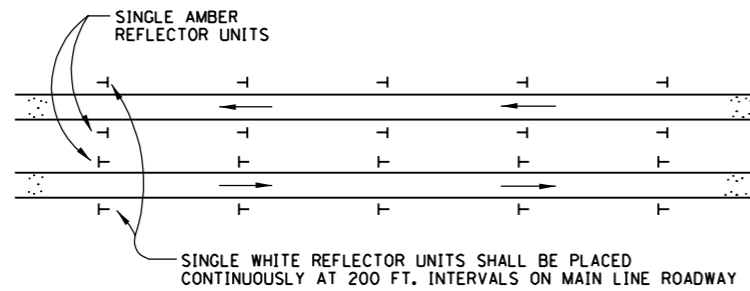

SINGLE AMBER REFLECTOR UNITS

SINGLE WHITE REFLECTOR UNITS SHALL BE PLACED CONTINUOUSLY AT 200 FT. INTERVALS ON MAIN LINE ROADWAY

**TANGENT PLACEMENT**

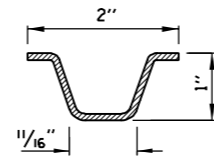

**SECTION A-A**  
STEEL- 1.12 LBS/FT.

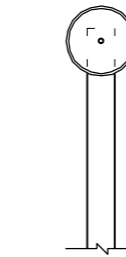

**SINGLE UNIT**

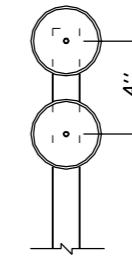

**DOUBLE UNIT**

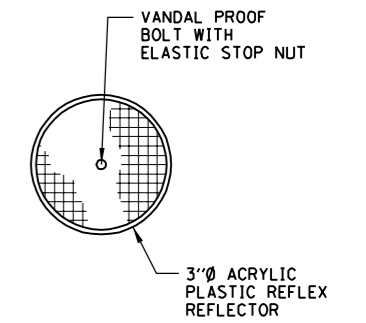

**DELINEATORS**

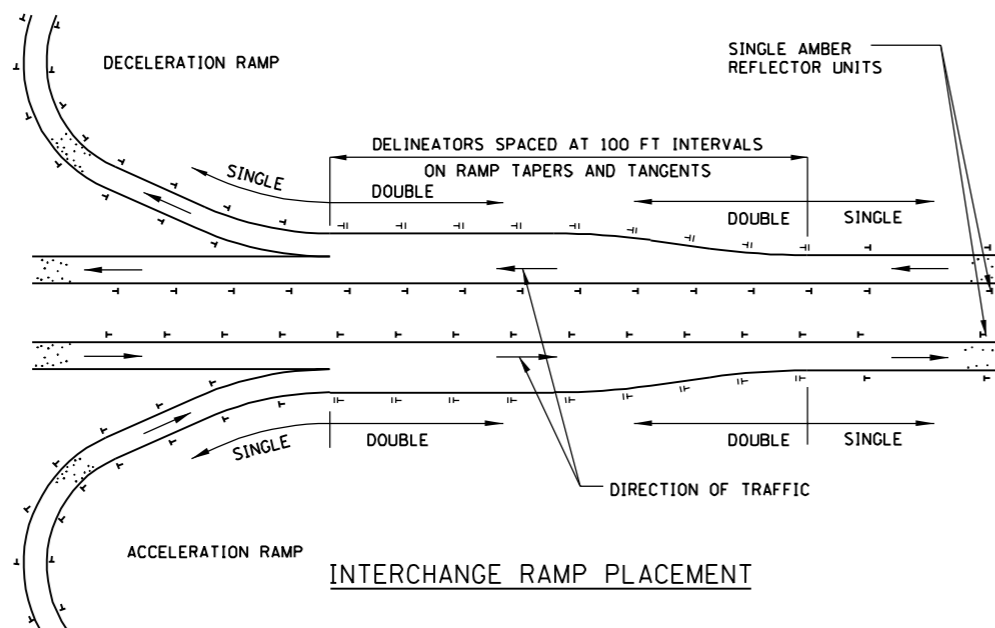

**INTERCHANGE RAMP PLACEMENT**

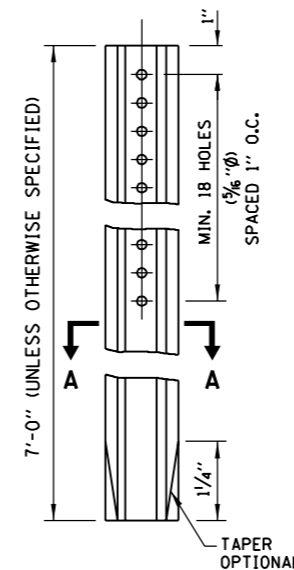

**STEEL POST**

**TYPICAL DELINEATORS**

**NOTES FOR DELINEATOR INSTALLATION:**

1. DELINEATORS ON TANGENT SECTIONS OF MAIN LINE SHALL BE PLACED AT 200 FOOT SPACING. DELINEATORS ON RAMPS AND ACCELERATION AND DECELERATION LANES SHALL BE PLACED AT MAXIMUM SPACING OF 100 FEET.
2. A. MAIN LINE-SINGLE WHITE REFLECTOR UNITS SHALL BE PLACED CONTINUOUSLY ON THE RIGHT AND SINGLE AMBER REFLECTOR UNITS SHALL BE PLACED ON THE LEFT ON MAIN LINE SECTIONS WITHOUT BARRIER WALL.  
B. RAMPS-SINGLE REFLECTOR UNITS SHALL BE PLACED ON THE OUTSIDE OF ALL CURVED SECTIONS OF RAMPS, SINGLE WHITE SHALL BE PLACED ON THE RIGHT SIDE AND AMBER ON THE LEFT SIDE. THE DELINEATORS SHALL BE OVERLAPPED FOR A SHORT DISTANCE TO CLEARLY INDICATE WHERE DELINEATION ON ONE SIDE OF THE RAMP ENDS AND DELINEATION ON THE OTHER SIDE APPEARS.  
C. DOUBLE WHITE REFLECTOR UNITS SHALL BE PLACED ON THE RIGHT AT ALL ACCELERATION AND DECELERATION LANES.
3. MEDIAN CROSSOVER DELINEATION-THE FOLLOWING DELINEATION SHOULD BE INSTALLED ON THE LEFT SIDE OF THE PAVEMENT APPROACHING CROSSOVER:
  - A. ONE-HALF OF A MILE IN ADVANCE OF THE CROSSOVER ONE WHITE REFLECTOR UNIT OVER THREE AMBER REFLECTOR UNITS.
  - B. ONE-FOURTH OF A MILE IN ADVANCE OF THE CROSSOVER ONE WHITE REFLECTOR UNIT OVER TWO AMBER REFLECTOR UNITS.
  - C. AT A POINT NEAR THE INTERSECTION OF THE EDGE OF THE LEFT SHOULDER AND NEAR EDGE OF THE CROSSOVER ONE WHITE REFLECTOR UNIT OVER ONE AMBER REFLECTOR UNIT.
4. DELINEATORS SHALL BE MOUNTED ON SUPPORTS SUCH THAT THE TOP OF REFLECTORS IS FOUR FEET ABOVE THE ROADWAY EDGE AND TWO FEET OUTSIDE THE OUTER EDGE OF THE PAVED SHOULDER OR TWO FEET MINIMUM AND SIX FEET MAXIMUM OUTSIDE THE BACKS OF CURBS OR GUTTERS.
5. IN ALL CASES, THE COLOR OF THE REFLECTORS SHALL BE THE SAME AS THE ADJACENT EDGE LINE EXCEPT AS SPECIFIED IN NOTE 3.

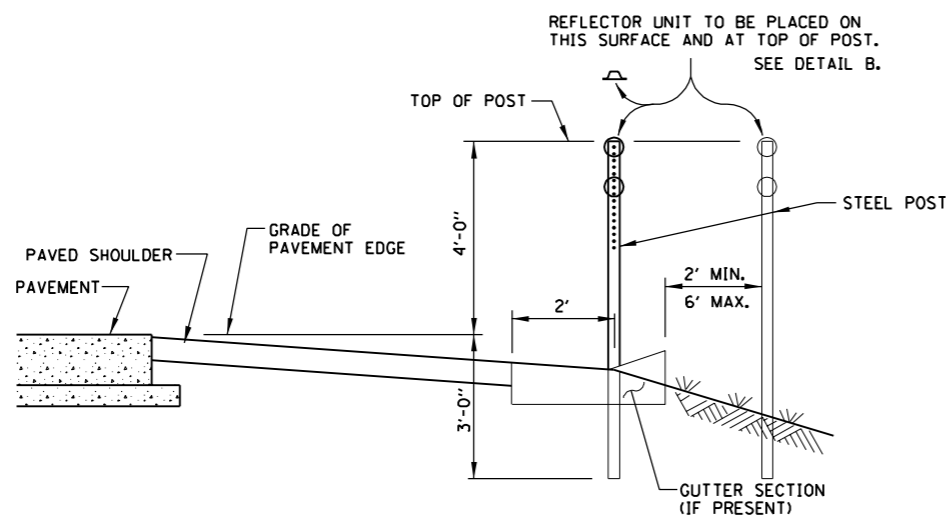

**DELINEATOR INSTALLATION**

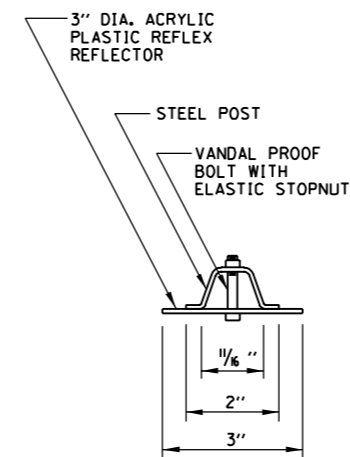

**DETAIL B**



DATE	REVISIONS
7-1-2009	CHANGED BARRIER TO F-SHAPE CONFIG. ADDED SECTION C-C NEW BARRIER DELINEATORS

DELINEATORS

STANDARD D4-01

APPROVED *Paul Kovacs* CHIEF ENGINEER DATE 7-1-2009



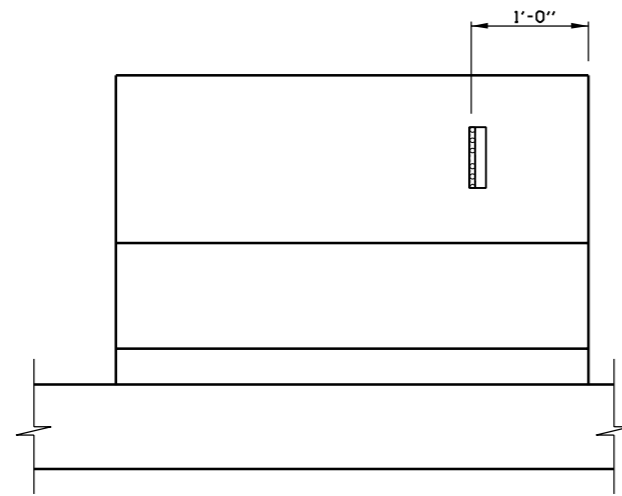

ELEVATION

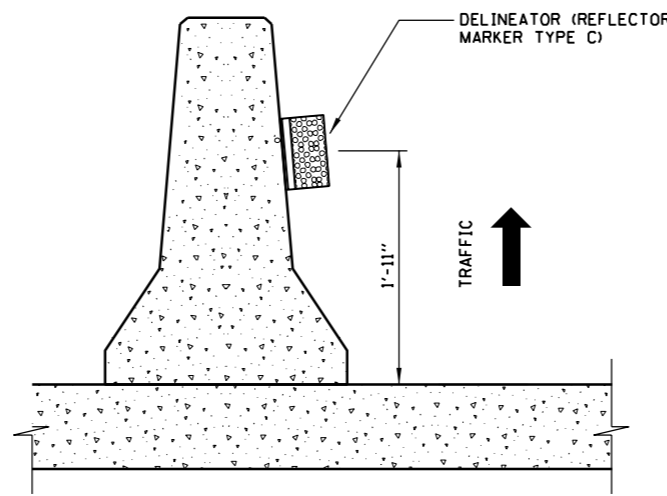

CROSS-SECTION

**MOVABLE CONCRETE BARRIER**

**NOTES FOR DELINEATOR:**

1. THE DELINEATORS SHALL BE PLACED AT 100 FOOT SPACINGS ALONG ROADWAY AND 50 FOOT ON BRIDGES AND THREE DELINEATORS AT 15 FOOT SPACINGS ON BRIDGE APPROACHES. THE SPACINGS ARE THE SAME FOR TANGENT AND CURVE ALIGNMENTS. WHITE DELINEATOR SHALL BE PLACED ON THE RIGHT SIDE AND AMBER ON THE LEFT SIDE.
2. REFLECTOR MARKERS TYPE B AND TYPE C SHALL HAVE REFLECTIVE SURFACE ON ONE SIDE ONLY.

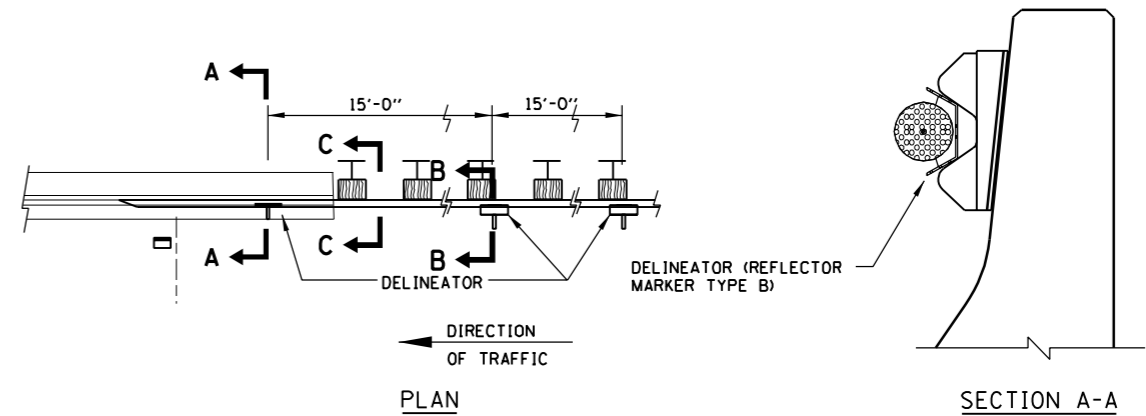

PLAN

SECTION A-A

**POST MOUNTED DELINEATOR SPACING ON CURVES**

RADIUS OF CURVE (FT.)	SPACING ON CURVE (FT.)	SPACING IN ADVANCE AND BEYOND CURVE (FT.)		
		1ST	2ND	3RD
LESS THAN 100	20	40	65	125
100 - 174	30	60	90	180
175 - 224	35	70	110	200
225 - 274	40	85	125	200
275 - 349	50	95	145	200
350 - 449	55	110	170	200
450 - 549	65	125	190	200
550 - 649	70	140	200	200
650 - 749	75	150	200	200
750 - 849	80	165	200	200
850 - 949	85	175	200	200
950 - 1049	90	185	200	200
1050 - 1299	100	200	200	200
1300 - 1999	125	200	200	200
2000 - 2999	150	200	200	200
3000 - 3999	175	200	300	200
MORE THAN 3999	200	200	200	200

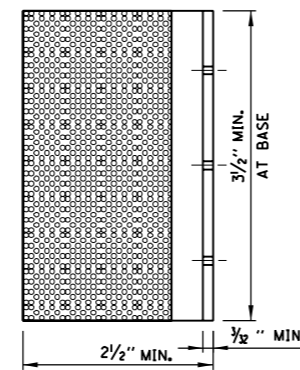

DELINEATOR  
(REFLECTOR MARKER TYPE C)

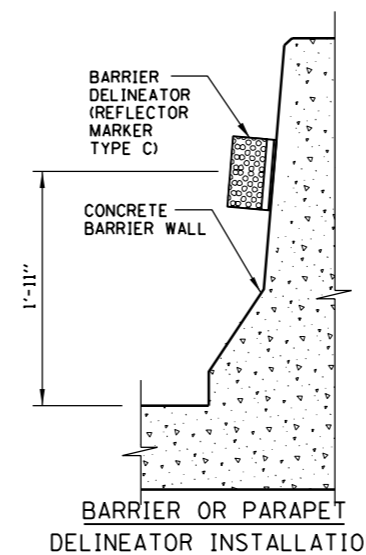

BARRIER OR PARAPET  
DELINEATOR INSTALLATION

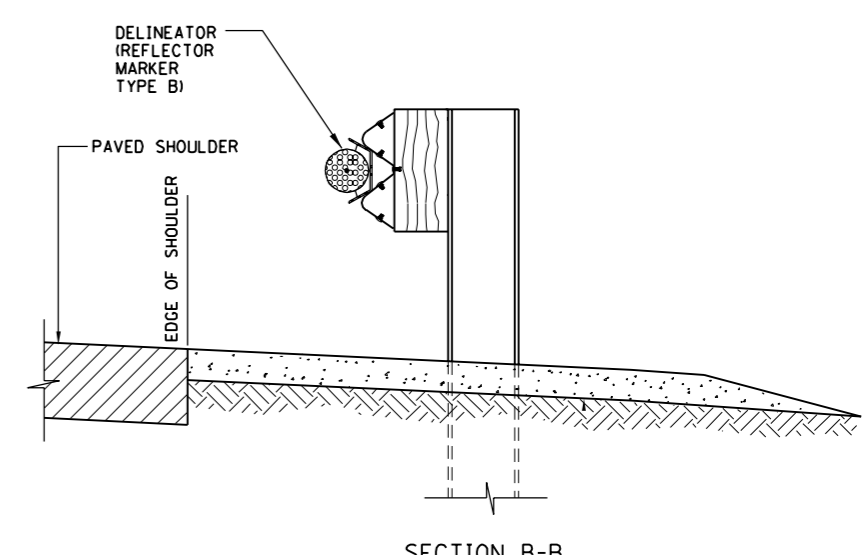

SECTION B-B

**DELINEATOR INSTALLATION ON GUARDRAIL  
AT BRIDGE APPROACHES**

ALSO SEE SHEET 1 (OF 2) IN THIS SERIES FOR ADDITIONAL INFORMATION

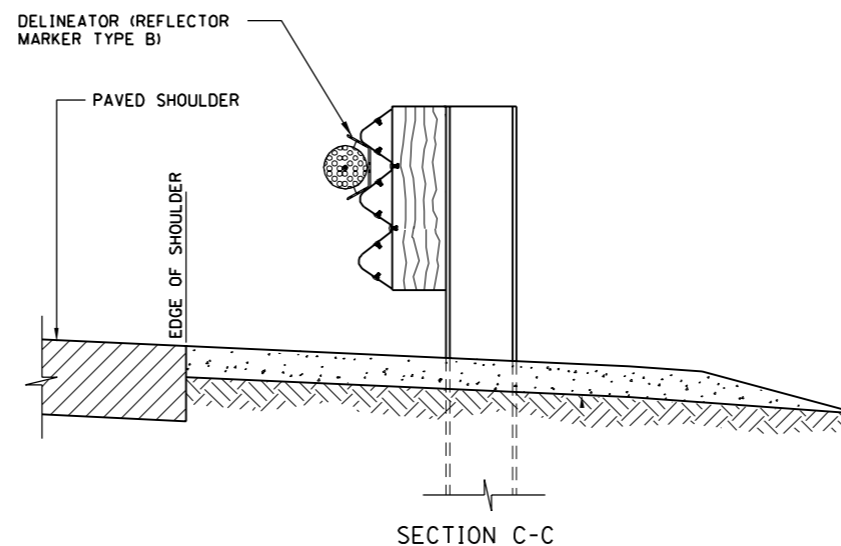

SECTION C-C

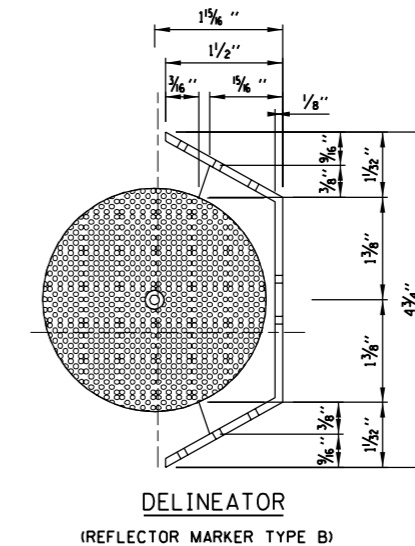

DELINEATOR  
(REFLECTOR MARKER TYPE B)

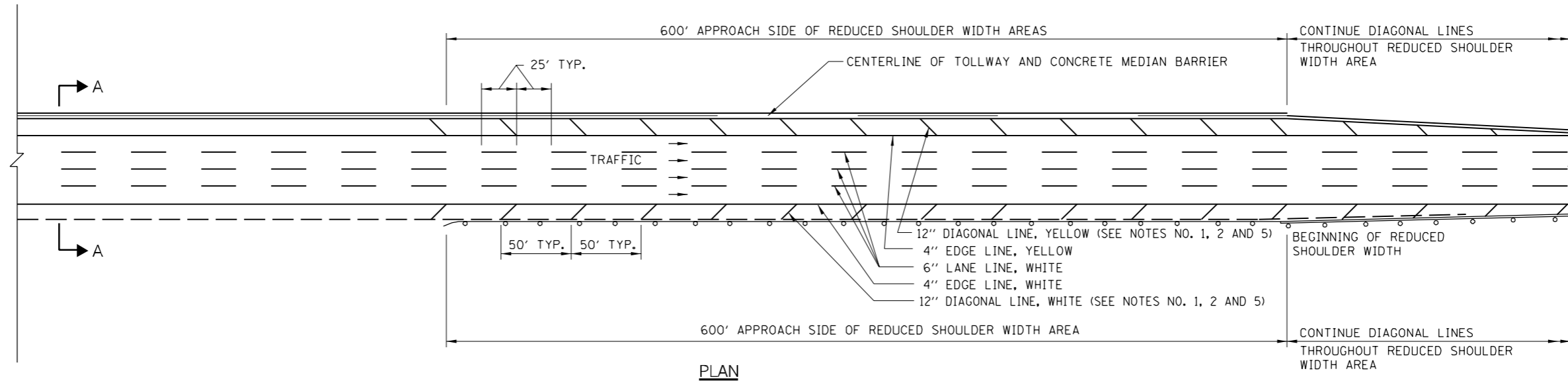

PLAN

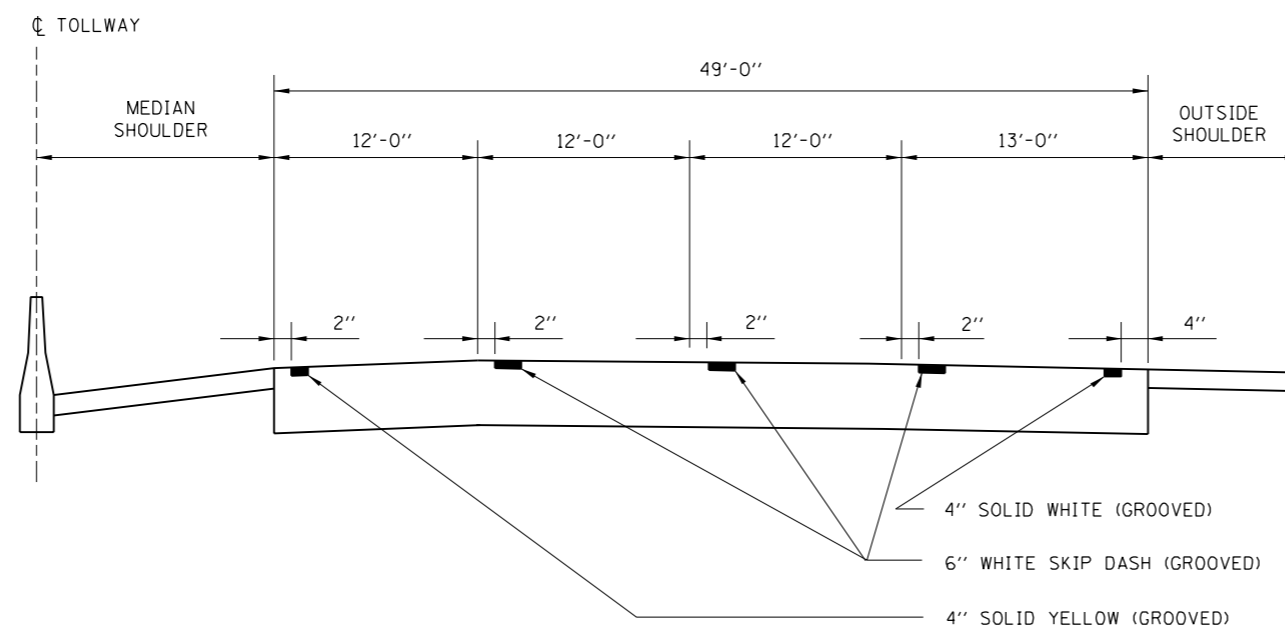

SECTION A-A

**GENERAL NOTES:**

1. DIAGONAL SHOULDER STRIPING REQUIRED WHERE HMA SHOULDER WIDTH IS LESS THAN 10'.
2. ROADWAY MARKING MATERIALS TO BE USED ON FINISHED CONCRETE SURFACE AND HOT-MIX ASPHALT SURFACE SHALL BE AS SHOWN ON THE PLANS.
3. WHERE THE GUARDRAIL ENCLOSES ON THE SHOULDER THE DIAGONAL MARKINGS SHALL EXTEND AS CLOSE TO THE FACE OF THE RAIL AS POSSIBLE.
4. ALL LANE LINES AND EDGE LINES SHALL BE GROOVED.
5. DIAGONAL STRIPING SHALL BE SURFACE APPLIED.
6. GORE STRIPING (CHEVRON) SHALL BE SURFACED APPLIED.

ROADWAY AND SHOULDER STRIPING - NEW CONSTRUCTION

APPROVED *Paul Kovacs* CHIEF ENGINEER DATE 7-1-2009

DATE	REVISIONS
9-19-2007	STRIPE LOCATION • OUTSIDE LANE
7-1-2009	ADDED LINE GROOVING NOTES

**Illinois Tollway**  
Open Roads for a Faster Future

PERMANENT PAVEMENT MARKINGS

STANDARD D5-02

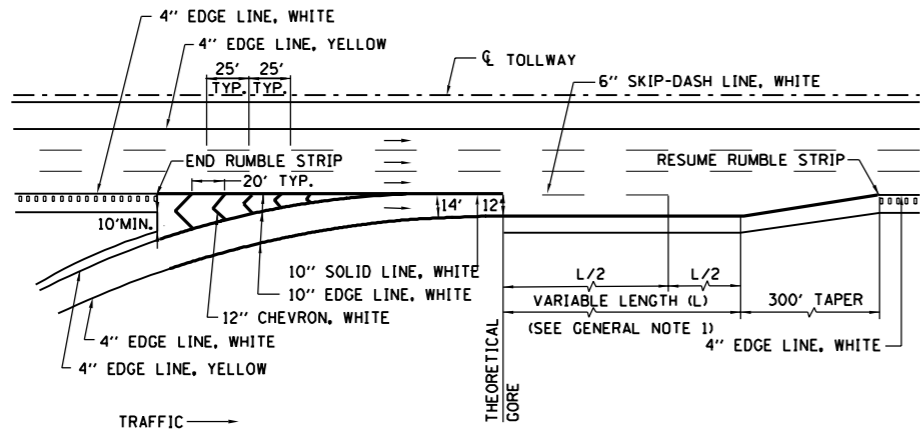

ENTRANCE - SINGLE LANE RAMP - PARALLEL TYPE

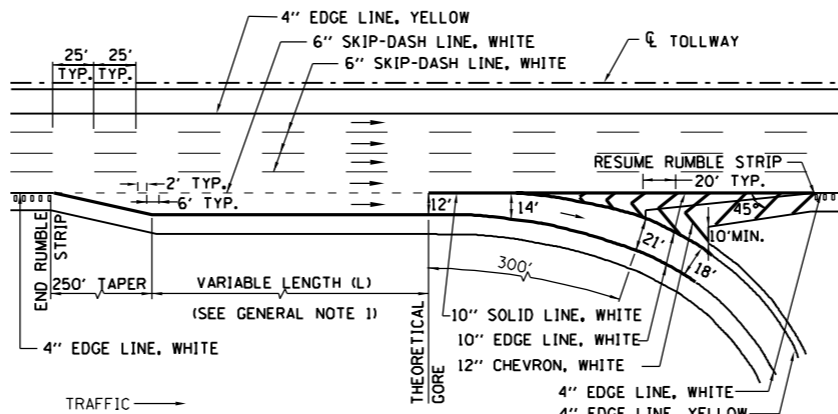

EXIT - SINGLE LANE RAMP - PARALLEL TYPE

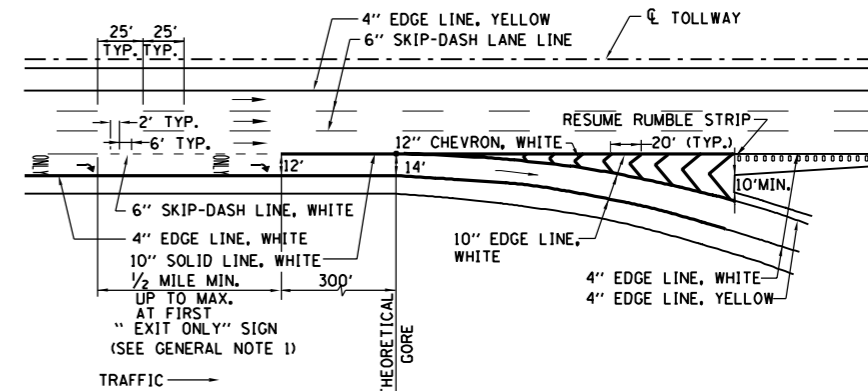

EXIT - SINGLE LANE RAMP - WITH AUXILIARY LANE

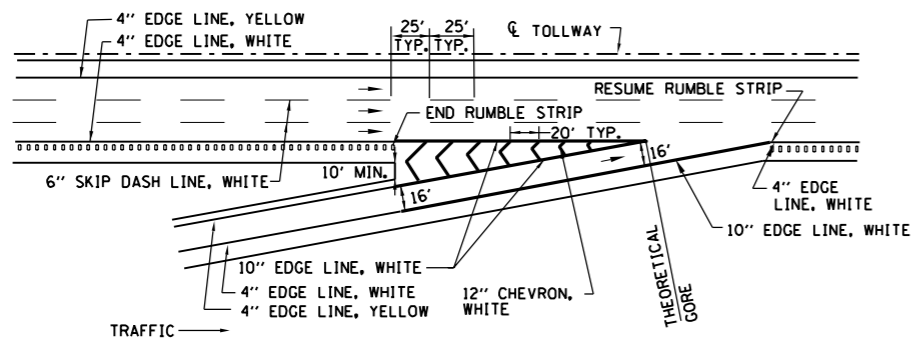

ENTRANCE - SINGLE LANE RAMP - TAPER TYPE

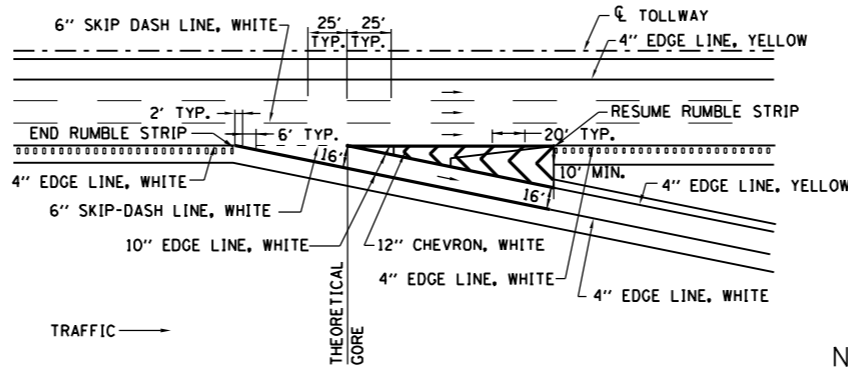

EXIT - SINGLE LANE RAMP - TAPER TYPE

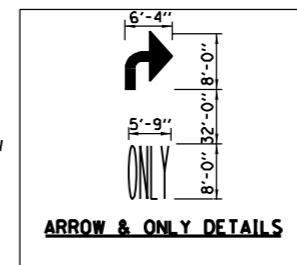

**NOTE:**  
PAVEMENT MARKING LETTERS AND SYMBOLS-ONLY AND ARROW ARE TO BE TYPICALLY PLACED AT 1/2 MILE EXIT ONLY GUIDE SIGN, AT GORE EXIT GUIDE SIGN AND APPROXIMATELY HALFWAY BETWEEN THE TWO.

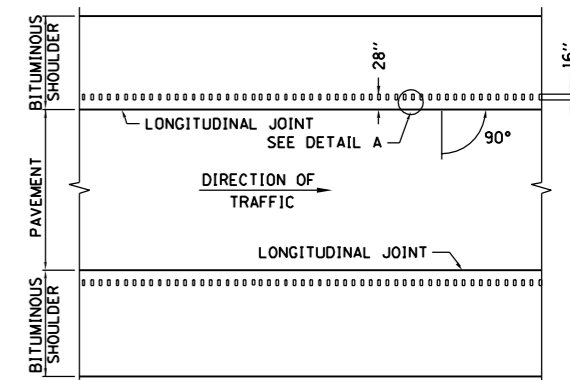

TYPICAL PLAN VIEW  
MAINLINE

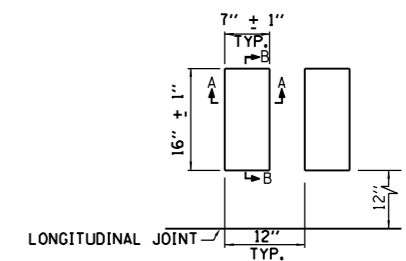

PLAN DETAIL A

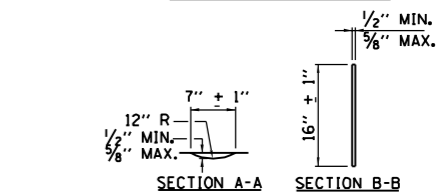

SECTION A-A SECTION B-B  
SHOULDER RUMBLE STRIP  
DETAILS

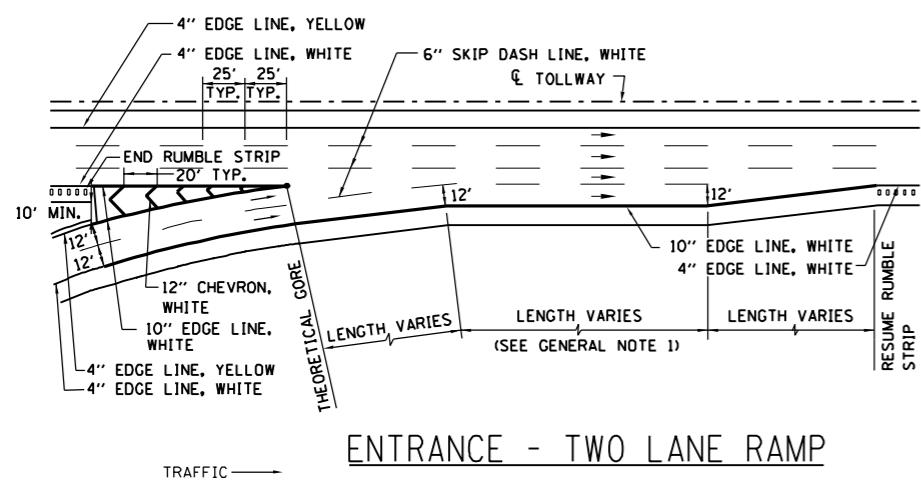

ENTRANCE - TWO LANE RAMP

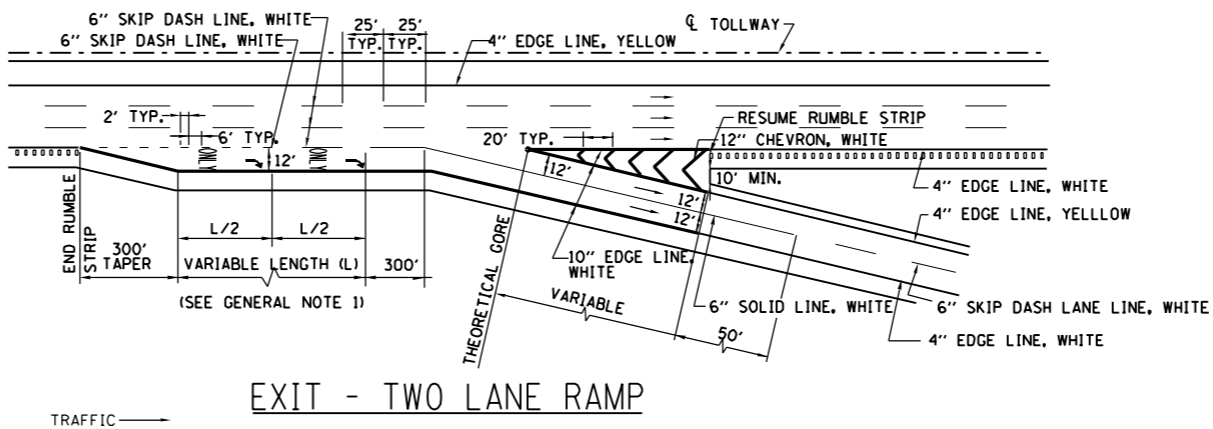

EXIT - TWO LANE RAMP

**GENERAL NOTES:**

1. RUMBLE STRIPS SHALL BE INSTALLED UP TO THE GORE WHEN AUXILIARY LANES, ACCELERATION LANES AND DECELERATION LANES, LENGTHS ARE GREATER THAN 1000 FT.
2. ROADWAY MARKING MATERIALS TO BE USED ON FINISHED CONCRETE SURFACE AND HOT-MIX ASPHALT SURFACE SHALL BE AS SHOWN ON THE PLANS.
3. ALL LANE LINES AND EDGE LINES SHALL BE GROOVED.
4. GORE STRIPING (CHEVRON) SHALL BE SURFACED APPLIED.
5. LETTERS AND SYMBOL MARKING SHALL BE SURFACED APPLIED.

APPROVED *Paul Kovacs* CHIEF ENGINEER DATE 7-1-2009

DATE	REVISIONS
7-1-2009	ADDED LINE GROOVING NOTES

SHEET 1 OF 2

**Illinois Tollway**  
*Open Roads for a Faster Future*

PAVEMENT MARKING  
AND SHOULDER  
RUMBLE STRIP DETAILS

STANDARD D6-01

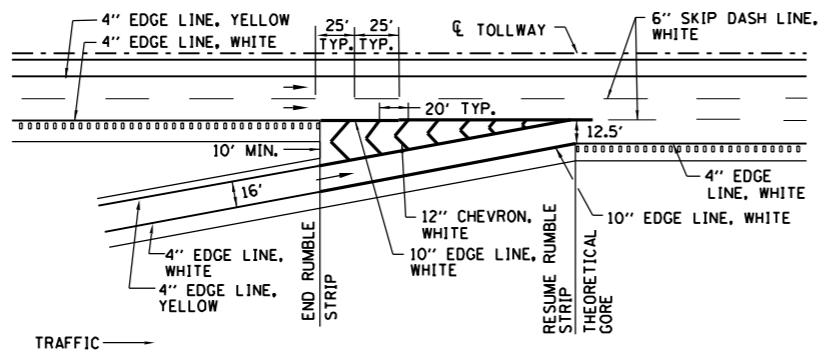

ENTRANCE - SINGLE LANE RAMP WITH  
BEGINNING OF LANE 3

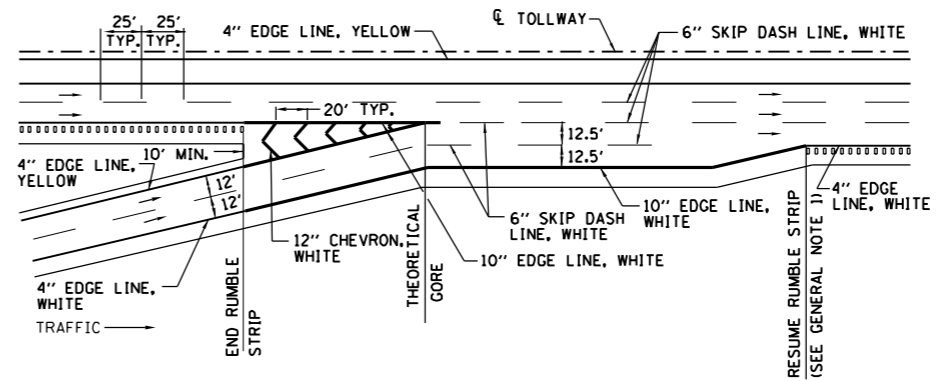

ENTRANCE - TWO LANE RAMP  
WITH BEGINNING OF LANE 3

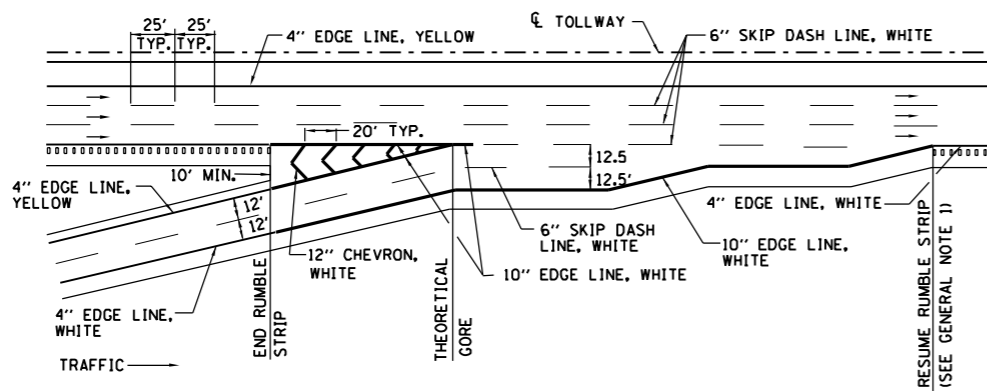

ENTRANCE - TWO LANE PARALLEL RAMP

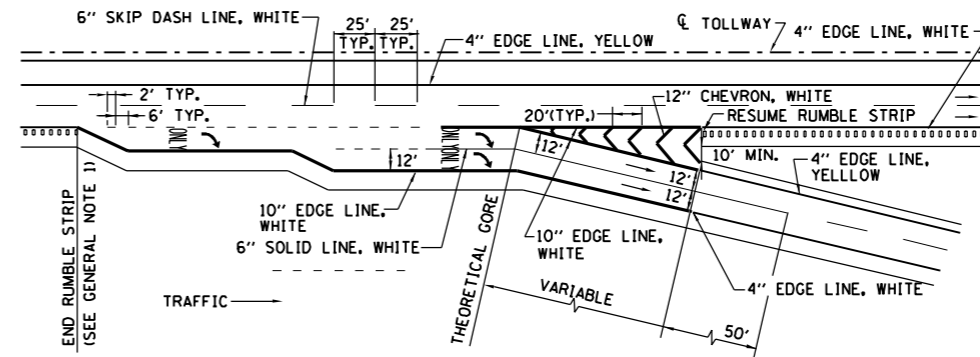

EXIT - TWO LANE PARALLEL RAMP

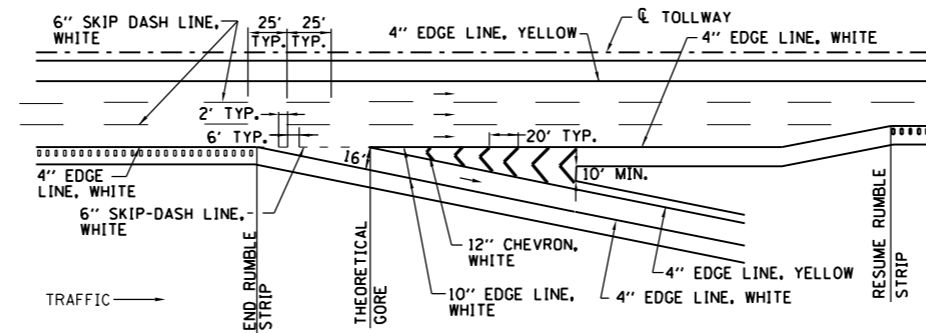

EXIT - SINGLE LANE RAMP  
LANE THREE TERMINATION

SEE SHEET 1 OF 2,  
IN THIS SERIES FOR  
GENERAL NOTES.



PAVEMENT MARKING  
AND SHOULDER  
RUMBLE STRIP DETAILS

STANDARD D6-01

APPROVED *Paul Kovacs* CHIEF ENGINEER DATE 7-1-2009

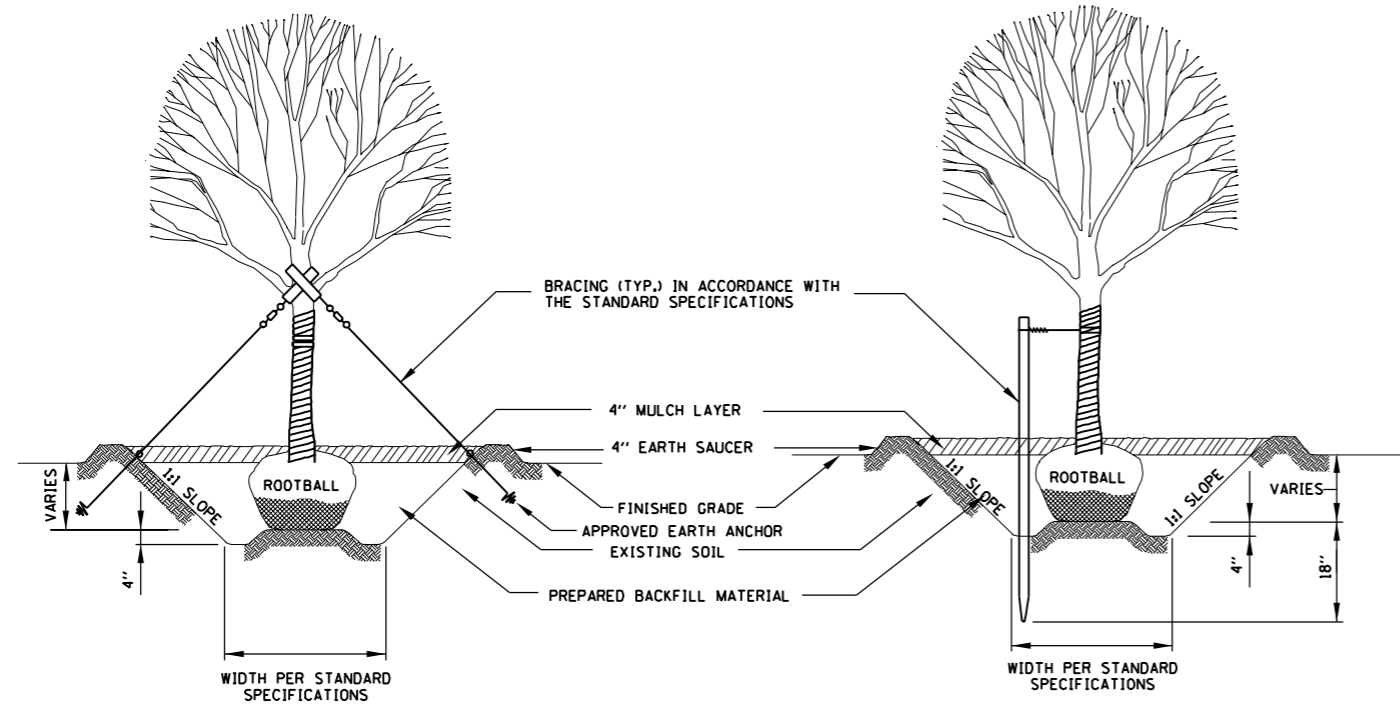

**DECIDUOUS TREE PLANTING DETAIL**  
(4 1/2" CALIPER AND LARGER)

**DECIDUOUS TREE PLANTING DETAIL**  
GREATER THAN 4 FT HEIGHT AND LESS THAN 4 1/2" CALIPER)

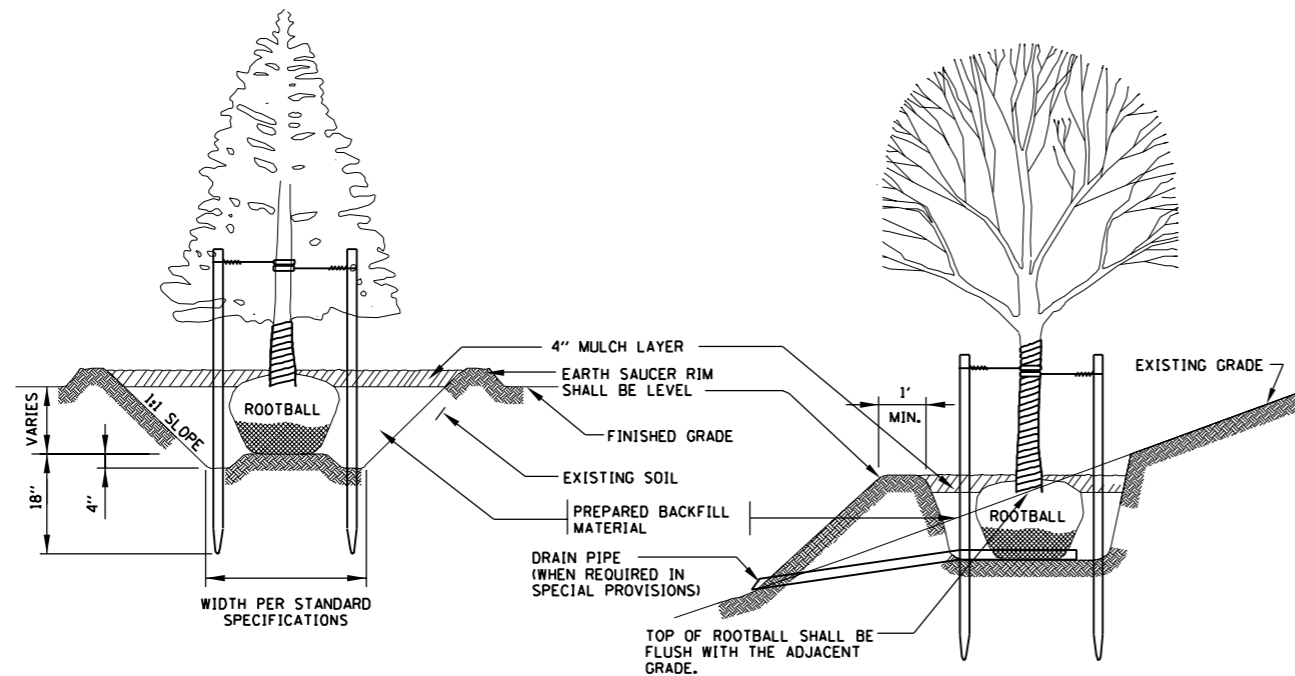

**EVERGREEN TREE PLANTING DETAIL**

**STEEP SLOPE PLANTING DETAIL**

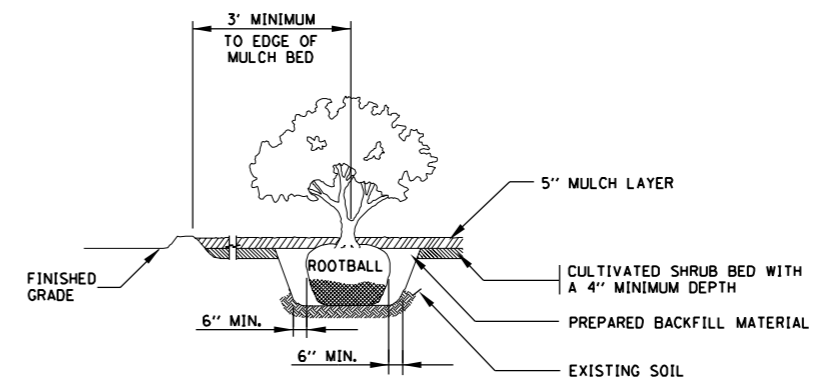

**SHRUB PLANTING DETAIL**

**PLANTING NOTES:**

1. THE CONTRACTOR SHALL VERIFY THE LOCATIONS OF ALL UNDERGROUND UTILITIES, FIBER OPTICS, STORM SEWERS AND DRAINAGE STRUCTURES IN THE FIELD PRIOR TO THE EXCAVATION OF ANY PLANT PITS OR PLANTING BEDS. LOCATIONS OF TREE AND SHRUB PLANTINGS SHALL BE ADJUSTED TO AVOID DAMAGING ANY UNDERGROUND FEATURES.
2. THE PLANT LOCATIONS SHOWN ON THE PLANS ARE APPROXIMATELY ONLY. THE EXACT LOCATIONS SHALL BE ADJUSTED AS REQUIRED IN THE FIELD BY THE ENGINEER. TREE LOCATIONS SHALL NOT BE MOVED CLOSER TO PAVEMENT EDGES THAN SHOWN ON THE PLANS OR A MINIMUM OF FIFTY (50) FEET.
3. TREES SHALL BE SPACED A MINIMUM OF FIVE (5) FEET FROM FENCES.
4. TREE AND SHRUB PLANTINGS SHALL NOT BLOCK ACCESS TO GATES IN FENCES.
5. TREES PLANTED IN TURF AREAS SHALL BE SPACED A MINIMUM OF TEN (10) FEET FROM THE EDGE OF A SHRUB BED.
6. TREES SHALL BE SPACED A MINIMUM OF TEN (10) FEET FROM NOISEWALLS OR OTHER STRUCTURES.
7. DITCHES SHALL BE KEPT CLEAR OF PLANTINGS. THE MINIMUM VERTICAL DISTANCE BETWEEN DITCH BOTTOMS AND PLANTS SHALL BE THREE (3) FEET.
8. IF DURING EXCAVATION, A PLANT HOLE OR PLANTING BED SHOWS POOR DRAINAGE, STANDING WATER OR AN IMPERVIOUS STRATUM OF SOIL, THE CONTRACTOR SHALL CEASE EXCAVATION AND SHALL NOTIFY THE ENGINEER. THE PLANT(S) SHALL BE RELOCATED AS DIRECTED BY THE ENGINEER AND THE HOLE(S) OR BED SHALL BE FILLED IN AND RESTORED TO MATCH THE CONDITION AND VEGETATION OF THE ADJACENT AREA.
9. IMPROPERLY PRUNED PLANTINGS WILL BE REJECTED AND REPLACEMENTS WILL IMMEDIATELY BE MADE BY THE CONTRACTOR.
10. THE SIDES OF ALL PLANT PITS SHALL BE LOOSENEED TO DISJOIN ANY GLAZING WHICH MAY OCCUR DURING THE DIGGING OPERATION.
11. TREE WRAPPING SHALL EXTEND TO THE LOWEST MAJOR BRANCH.
12. TOP OF ROOTBALL SHALL BE APPROXIMATELY 2 INCHES ABOVE ADJACENT FINISHED GRADE.
13. SHRUB PLANTINGS:
  - A. UNLESS NOTED OTHERWISE, ALL SHRUBS SHALL BE PLANTED IN MULCHED BEDS. THE EDGE OF THE MULCH BED SHALL EXTEND A MINIMUM OF THREE (3) FEET BEYOND THE CENTERS OF THE PERIPHERAL PLANTS IN THE BED.
  - B. THE EDGE OF A MULCH BED FOR SHRUB PLANTINGS ADJACENT TO A WALL, FENCE, GUARDRAIL OR OTHER FIXED OBJECT SHALL EXTEND TO THE OBJECT. THE PERIPHERAL PLANTS IN THE BED SHALL NOT BE PLANTED WITHIN FIVE (5) FEET OF THE OBJECT.
  - C. WHEN A TREE IS LOCATED IN A SHRUB BED, THE MINIMUM DISTANCE BETWEEN THE TREE AND THE ADJACENT SHRUBS SHALL BE SIX (6) FEET.
14. THE CONTRACTOR SHALL RESTORE ALL AREAS, OBJECTS AND VEGETATION DISTURBED BY THE LANDSCAPE OPERATIONS TO ORIGINAL CONDITIONS.
15. STAKES, GUYWIRES AND ALL TREE SUPPORTS SHALL BE REMOVED AFTER ONE YEAR OR AS DIRECTED BY THE LANDSCAPE ARCHITECT.
16. REMOVE ALL TWINE, ROPE, WIRE AND BURLAP FROM TOP HALF OF ROOTBALL. THE LOWER HALF OF BURLAP SHALL BE FOLDED TOWARD THE BOTTOM OF THE ROOTBALL.

APPROVED *Jeff Daley* DATE 1-1-2007  
CHIEF ENGINEER

DATE	REVISIONS



LANDSCAPE PLANTING  
DETAILS

STANDARD D7-00

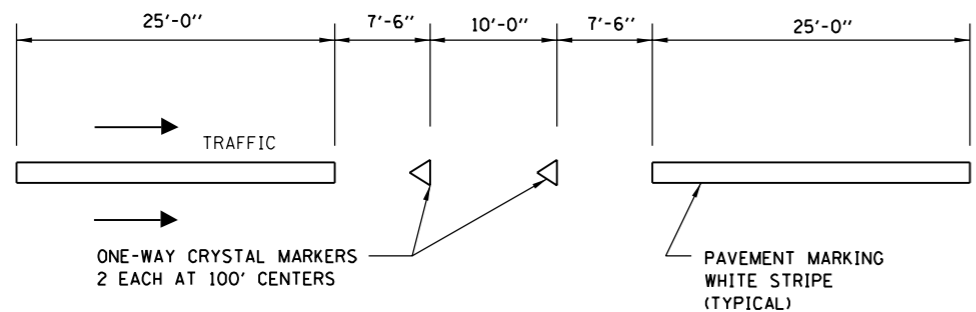

DETAIL A

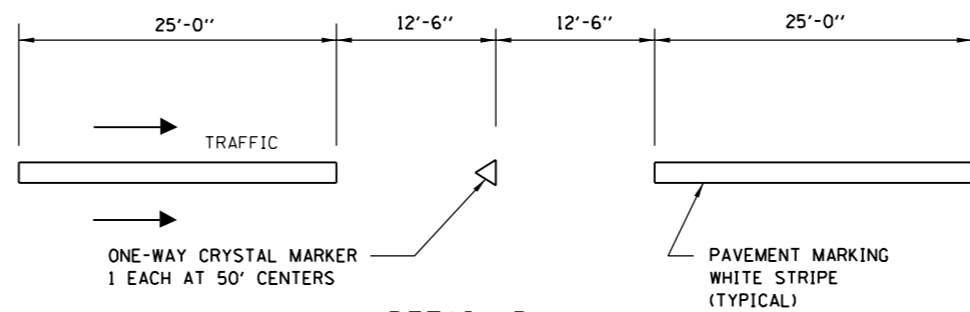

DETAIL B

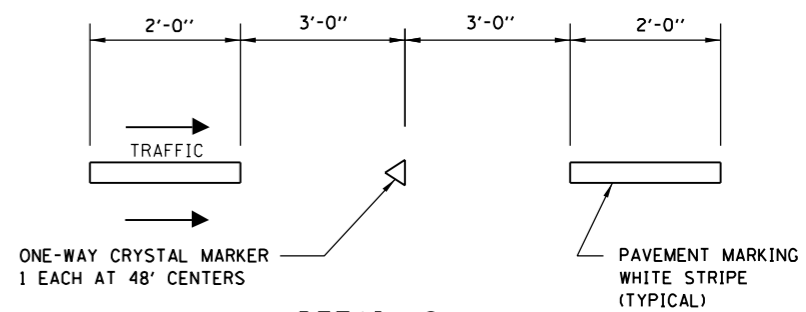

DETAIL C

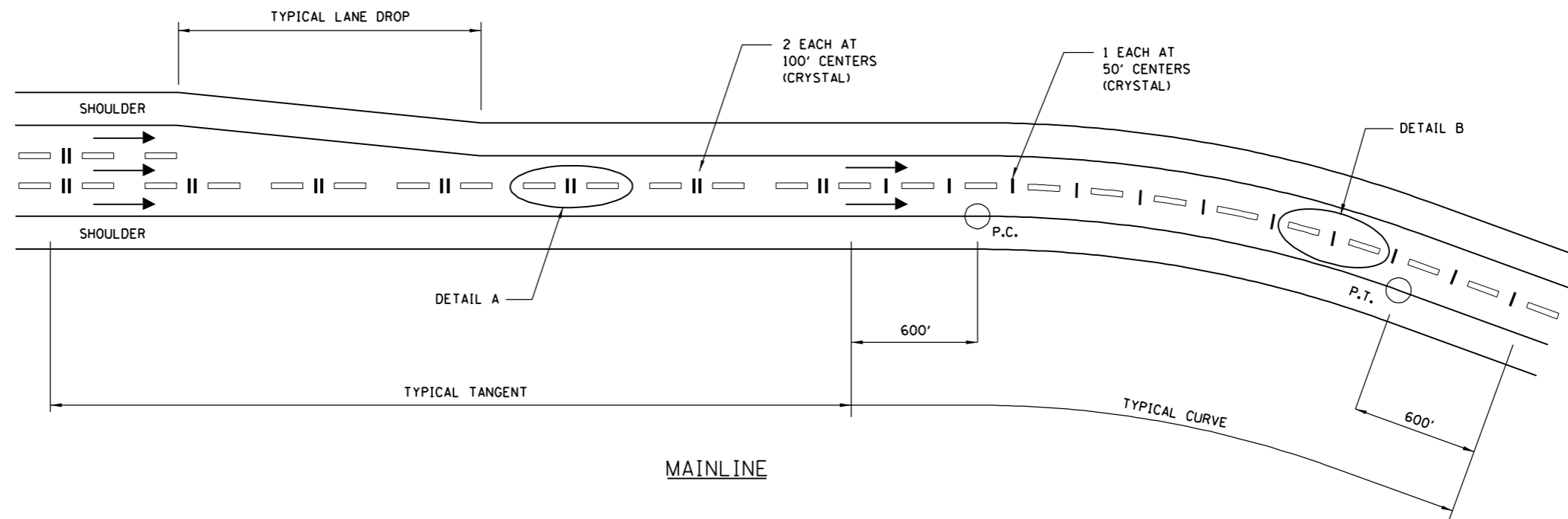

MAINLINE

NOTES:

1. FOR COLLECTOR DISTRUBUTOR, PLACE ONE-WAY CRYSTAL MARKER, 2 EACH AT 100' CENTERS. USE DETAIL A.
2. FOR MULTI LANE DIRECTIONAL RAMPS, PLACE ONE-WAY CRYSTAL MARKER, 1 EACH AT 50' CENTERS. USE DETAIL B.
3. FOR AUXILIARY LANES, PLACE ONE-WAY CRYSTAL MARKER, 1 EACH AT 48' CENTERS. USE DETAIL C.

RAISED PAVEMENT LANE MARKER DETAILS

APPROVED *Paul Kovacs* CHIEF ENGINEER DATE 7-1-2009

DATE	REVISIONS

**Illinois Tollway**  
Open Roads for a Faster Future

RAISED PAVEMENT LANE MARKER

STANDARD D8-00